



EXPOSITOR TEC-ART





PIEZAS DEL EXPOSITOR

1 Taco de separación entre la base y suelo.
2 unidades.

Para colocación en **1**



4 Base del expositor.
2 unidades.

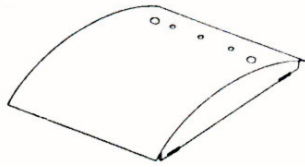

2 Cable tensor del panel.
1 unidad.

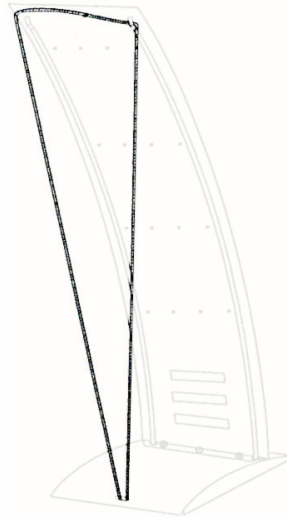

3 Panel del expositor.
1 unidad.

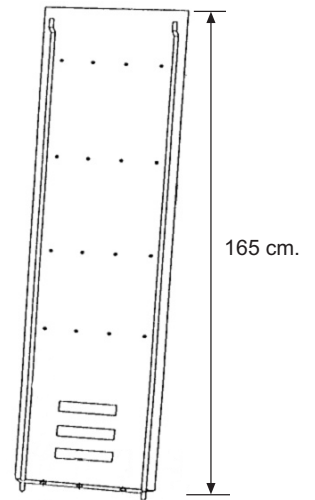

5 Tornillos sujeta panel.
2 unidades.

Para colocación en **4**

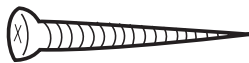

6 Piezas Iluminación.
Accesorio Opcional.

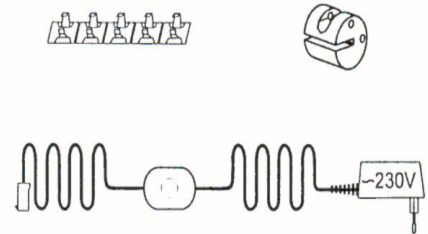
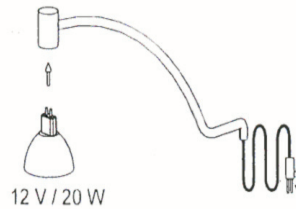

7 Estructura sujeta prospectos grande, tamaño A4.
Accesorio Opcional.

Para colocación en **2**



8 Estructura sujeta prospectos pequeña, tamaño 1/3 A4.
Accesorio Opcional.

Para colocación en **2**



9 Carpeta Metacrilato Adhesivo.
Accesorio Opcional.

Para colocación en **3**

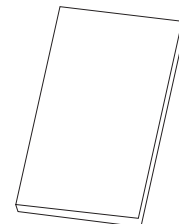



MONTAJE DEL EXPOSITOR:

- 1** Colocación de los tacos y el cable tensor en la base del expositor.

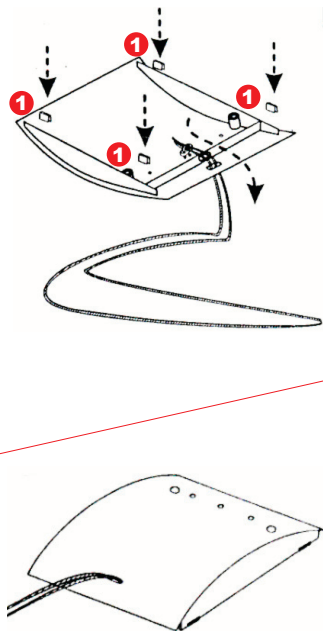

- 2** Anclaje del panel en la base del expositor.



- 3** Colocación del cable tensor en el panel.

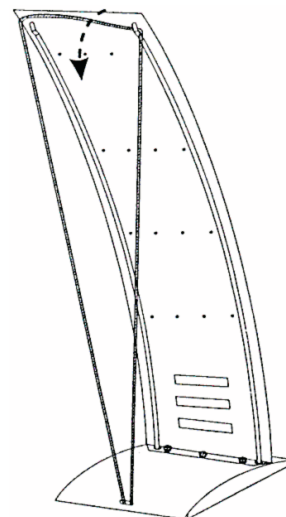

- 4** Colocación de las estructuras para la sujeción de los prospectos.

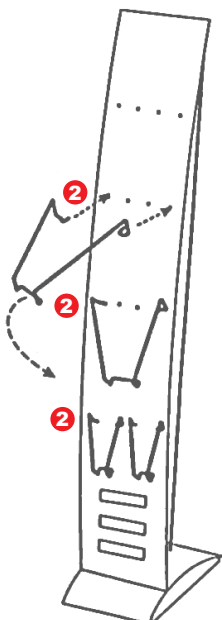

- 5** Colocación de la carpeta adhesiva del expositor.

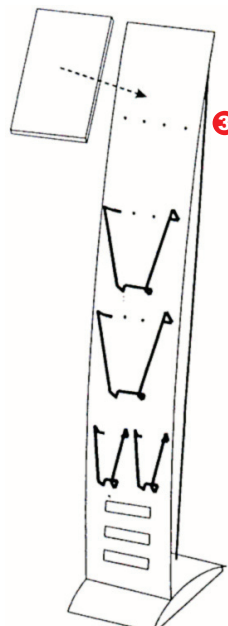



MONTAJE DE LA LAMPARA:

PIEZAS DE LA LAMPARA

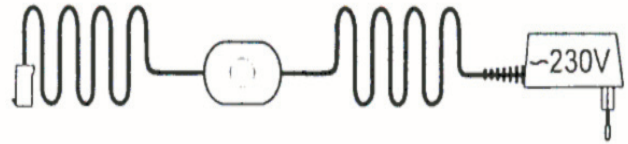
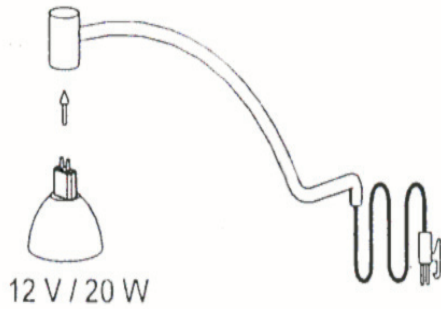

1 TIPO A

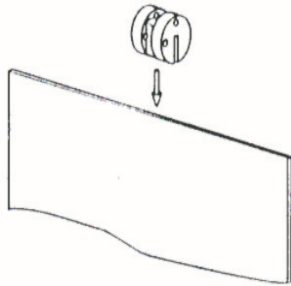

1 TIPO B

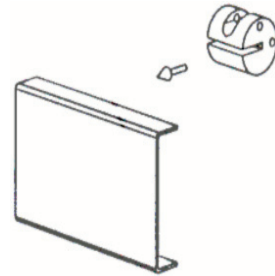

2

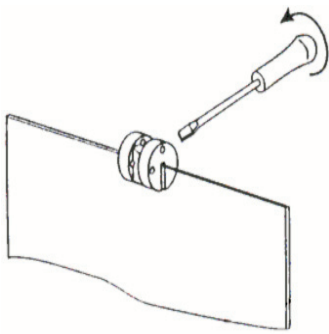

2

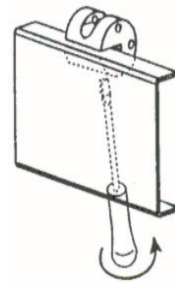

3

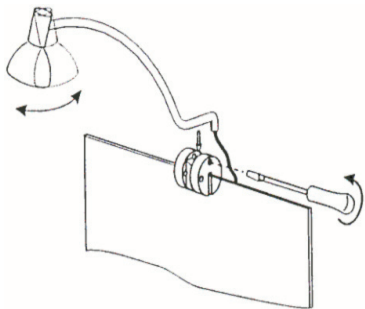

4

